







ST 010 201 0705



- saillie 200 mm
- bec déverseur fixe
- forme de jet rectangulaire avec 40 jets individuels
- diamètre de percement des robinets latéraux 35 mm
- diamètre de percement du bec 40 mm
- rosace 60 x 60 mm
- débit maxi. 4,5 l/min
- sans plomb
- Ce produit contribue au respect des exigences des systèmes d'évaluation des bâtiments écologiques, par exemple LEED®, BREEAM®, DGNB

	Chrome	ST 010 201 0705-00
	Platine brossé	ST 010 201 0705-06
	Dark Chrome	ST 010 201 0705-19
	Champagne brossé (Or 22cts)	ST 010 201 0705-46
	Champagne (Or 22cts)	ST 010 201 0705-47
	Dark Platinum brossé	ST 010 201 0705-99

Composants individuels de ce set

Ce set requiert les composants suivants

1x 13 800 705-00



1x 36 607 706-00









1x 36 607 707-00



ST 010 201 0705



- saillie 200 mm
- bec déverseur fixe
- forme de jet rectangulaire avec 40 jets individuels
- diamètre de percement 37 mm
- sans plomb
- raccord 1/2"
- montage de la fiche
- débit maxi. 4,5 l/min
- Ce produit contribue au respect des exigences des systèmes d'évaluation des bâtiments écologiques, par exemple LEED®, BREEAM®, DGNB

	Chrome	13 800 705-00
	Platine brossé	13 800 705-06
	Dark Chrome	13 800 705-19
	Champagne brossé (Or 22cts)	13 800 705-46
	Champagne (Or 22cts)	13 800 705-47
	Dark Platinum brossé	13 800 705-99

Accessoires recommandés



- Coude mural à encastrer -** 35 085 970 90
- profondeur de montage max. 163 mm
 - profondeur de montage mini. 90 mm

ST 010 201 0705

mm [inches]



Diagramme de débit



Certificats

LGA_28685. IAPMO_N-4976. IAPMO_8834 (1). IAPMO_4976 (6). WRAS_1512013.

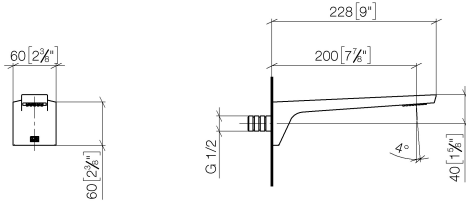
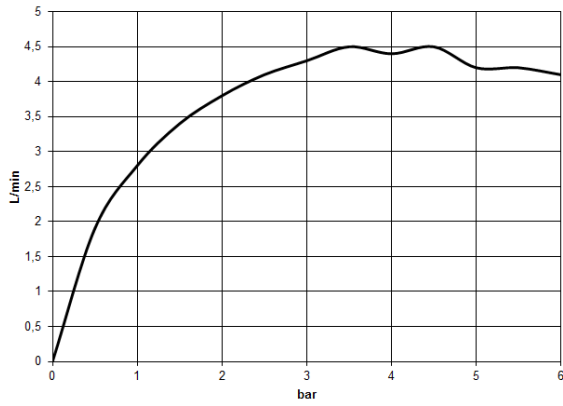
IAPMO_6397.

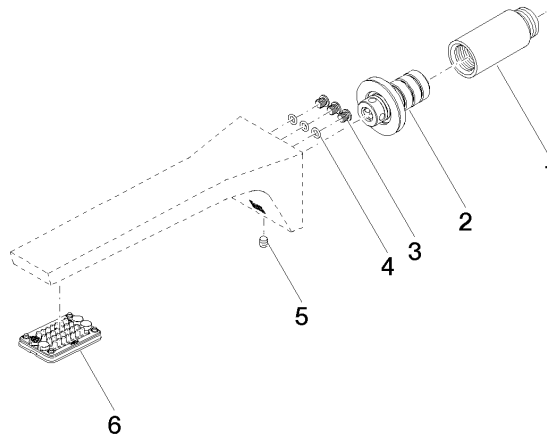







Liste des pièces de rechange

N°	Article Numéro	Désignation	Fréquence de montage	Délai de livraison
1	09 24 03 081 10 90	rallonge	1	2
2	90 24 03 108 01 90	set deraccord à vis	1	2
3	09 30 30 113 20 90	vis	3	2
4	09 14 10 001 90	joint	3	2
5	90 31 11 004 00 90	tige	1	2
6	90 11 02 297 00 90	mousseur	1	2

ST 010 201 0705



- rosace 60 x 60 mm
- avec marquage froid
- tête de commande avec broche et douille à sectionner

	Chrome	36 607 706-00
	Platine brossé	36 607 706-06
	Dark Chrome	36 607 706-19
	Champagne brossé (Or 22cts)	36 607 706-46
	Champagne (Or 22cts)	36 607 706-47
	Dark Platinum brossé	36 607 706-99

Accessoires requis



- Robinet à encastrer 1/2" -** 35 607 970 90
- profondeur de montage max. 150 mm
 - profondeur de montage mini. 105 mm

ST 010 201 0705

mm [inches]

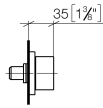
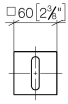

Certificats

DVGW_DW-
6501DN0116.

IAPMO_4976 (1).

LGA_29931.

WRAS_2010066.

LGA_29932.

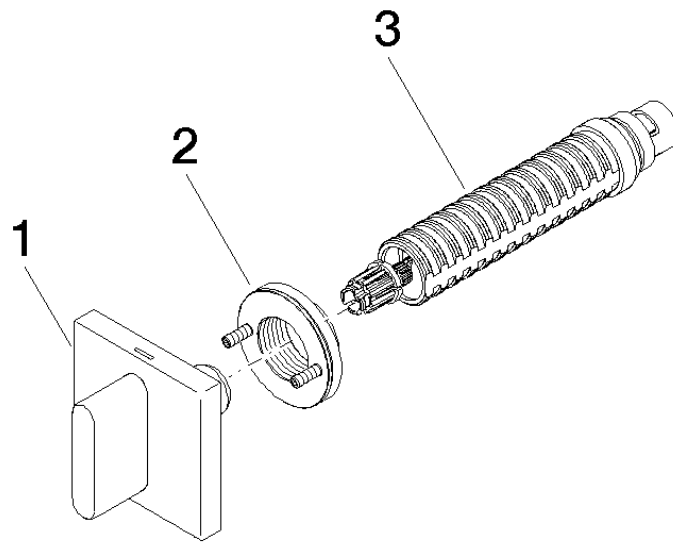







Liste des pièces de rechange

N°	Article Numéro	Désignation	Fréquence de montage	Délai de livraison
1	90 20 70 051 02-00	poignée (cold)	1	10
2	90 21 02 108 00 90	rondelle	1	2
3	90 90 03 143 00 90	tête céramique	1	2

ST 010 201 0705



- rosace 60 x 60 mm
- avec marquage chaud
- tête de commande avec broche et douille à sectionner

	Chrome	36 607 707-00
	Platine brossé	36 607 707-06
	Dark Chrome	36 607 707-19
	Champagne brossé (Or 22cts)	36 607 707-46
	Champagne (Or 22cts)	36 607 707-47
	Dark Platinum brossé	36 607 707-99

Accessoires requis



- Robinet à encastrer 1/2" -** 35 607 970 90
- profondeur de montage max. 150 mm
 - profondeur de montage mini. 105 mm

ST 010 201 0705

mm [inches]

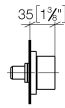
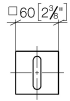

Certificats

DVGW_DW-
6501DN0116.

IAPMO_4976 (1).

LGA_29931.

WRAS_2010066.

LGA_29932.

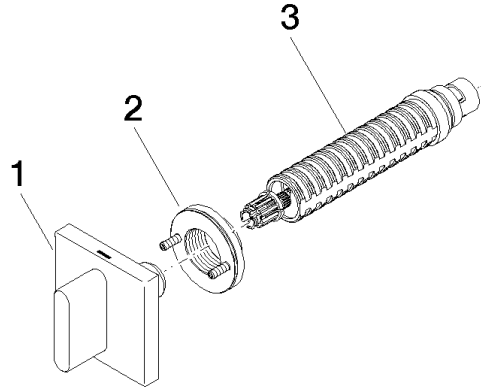

Liste des pièces de rechange

N°	Article Numéro	Désignation	Fréquence de montage	Délai de livraison
1	90 20 70 051 03-00	poignée (hot)	1	10
2	90 21 02 108 00 90	rondelle	1	2
3	90 90 03 142 00 90	tête céramique	1	2